

Survey of Current Solvent Extraction Equipment

E.D. MILLIGAN, Vice-President, Oilseed and Protein Processing, EMI Corporation, Des Plaines, Illinois, USA



ABSTRACT

The various designs and types of equipment currently in use are reviewed with the objective of presenting a survey of current practice in continuous extraction with comments on special features, innovations, and improvements.

INTRODUCTION

Solvent extraction, in our industry, is primarily concerned with the recovery of lipids from a seed structure which has been prepared to facilitate its penetration by a solvent, and then diffusion of the lipid-solvent mixture or miscella to the surface of the solid. This is generally easy to accomplish. What is more difficult to achieve is countercurrent washing of the miscella on the surface of the solids with successively less concentrated solvents, to achieve low residual lipids concentration in the final product.

EXTRACTOR

The heart of this process is the extractor, which must perform the following functions: first, it must convey large volumes of solids and provide a substantial retention time, ranging from 30 min to 2 hr; second, it must efficiently contact these large volumes of solids with equally large volumes of circulating liquids; and finally, it must efficiently separate the liquids and solids in such a way as to minimize stage-to-stage carryover of liquid on solids.

Percolation Extractors

The most common extractor design used today worldwide is the percolation type in its many variations, where liquid solvent or miscella is pumped over a bed of flakes or cake, percolates down through the bed, and leaves the bed at the bottom through a perforated plate, mesh screen, or wedge wire screen bar system (Fig. 1).

All of these are similar in principle of operation. They differ only in the mechanical design utilized to carry out the principle. The percolation system has been generally accepted because it is more adaptable to larger capacities in limited space. Its utilization of plant volume is considered to be more efficient than the immersion type. This is because the percolation bed is more dense and compact

than the dispersed solids volume in the immersion extractor, and the liquid volume is much less (Fig. 2). Also, transporting large volumes of solids in cells or baskets is easier mechanically than transporting by chain or screw conveyor the same volume of solids through a pool of liquid. In addition, drainage of liquid from solid is more easily accomplished mechanically in the percolation extractor.

Rotary type: Percolation extractors currently in use and available are in several categories. First, there is the rotary type, essentially a vertical cylindrical shell within which are baskets or cells, either rotating or stationary, around a central shaft. The process design of both the rotating and stationary basket system is schematically shown in Figure 3. The fresh solvent is pumped in before the discharge of the spent, extracted flakes; then they are allowed to drain before being dropped into the discharge hopper. Miscella is pumped countercurrently to the flow of flakes, becoming

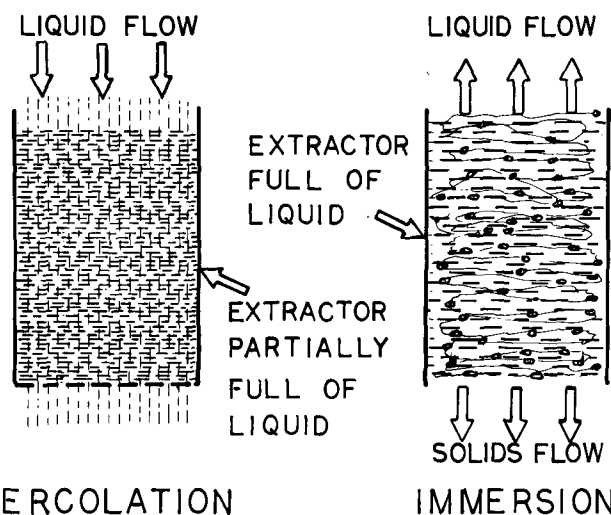

FIG. 2. Liquid flow of percolation extractor versus immersion extractor.

PERCOLATING LIQUID

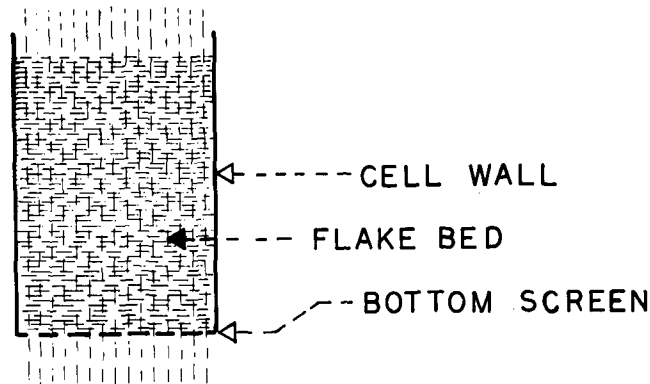

FIG. 1. Percolation system.

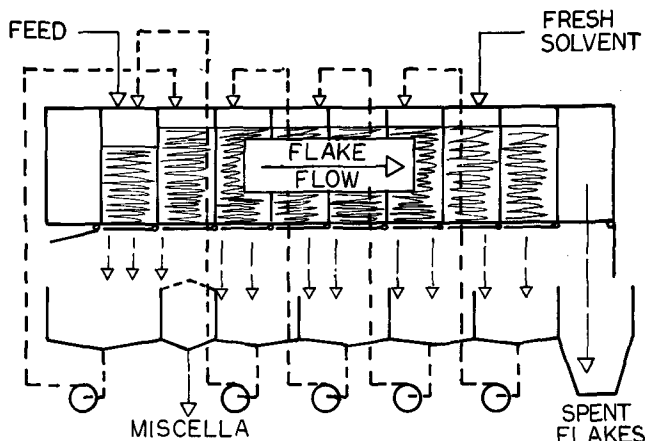

FIG. 3. Design for either rotating or stationary basket extraction system.

COUNTER-CURRENT FLOW

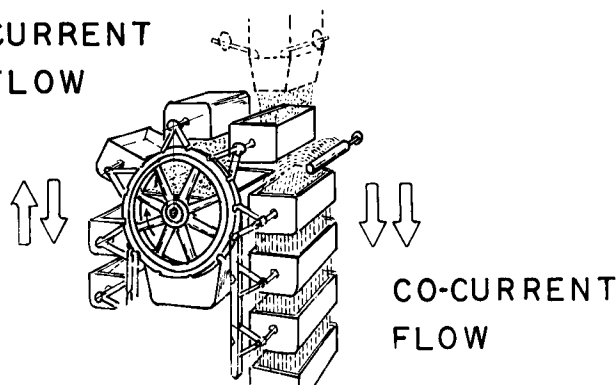

FIG. 4. Vertical basket extractor design.

richer as oil is extracted, and finally is pumped over a bed of fresh flakes for filtration and leaves the extractor as full miscella.

Of the rotating type are the Dravo Rotocel, the first of this type offered, which appeared in 1949 and is licensed by Simon-Rosedowns and Krupp, and the EMI Rotary Extractor in use since 1963. In both of these, cells with hinged perforated bottom doors rotate on a central rotor. The Extraktionstechnik Carousel has open bottom cells which rotate on a fixed wedge-wire screen. These three designs are similar in that the cells and material rotate; they differ mainly in the design of the cell bottom liquid separating device.

Of opposite design is the French Stationary Basket Extractor, also licensed by Speichim, in which the cells and perforated doors are fixed and the liquid manifolds and solids hopper rotate.

Chain and basket type: The functions of conveying and liquid-solid separating are accomplished in the chain and basket type of percolation extractor by transporting the flakes in separate baskets with fixed perforated bottoms. The baskets are rotatable, are carried on trunnions, and are moved by double chains. The design of the early units was vertical, but now most are horizontal.

The process design and miscella flow in the vertical units is a combination of countercurrent and co-current miscella flow (Fig. 4). In the descending column, half miscella is pumped over the bed at the top of the column and descends co-currently with the raw flakes, absorbing oil and becoming full miscella at the bottom of this column. Then the baskets turn and rise, countercurrent to the flow of fresh solvent pumped to the top of the ascending column, the liquid stream becoming "half" miscella at the bottom which is pumped to the top of the descending column. This design is relatively inflexible in that the miscella percolation rates are not adjustable from stage to stage.

It has been largely superseded by the horizontal design (Fig. 5), in which the process design and miscella flow are similar to the rotary type percolation extractor. In this horizontal design, the liquid flow in each stage is controlled by some combination of recirculation and advancement of the miscella, either by adjustment of the liquid manifolds or positioning of the stage dividers. This design is more flexible, and the horizontal layout is more convenient to operate than the vertical extractor. As a result, there are few vertical designs now offered. Both types discharge the extracted solids by rotating the baskets and dropping the flakes into a discharge hopper.

The horizontal chain and basket extractors currently available are from H.L.S. Ltd., manufactured in Israel; Lurgi Apparate-Technik of Frankfurt; Gianazza of Legnano, in Italy; and Bernardini (used in combination with their immersion extractor).

Perforated belt type: The third type of percolation

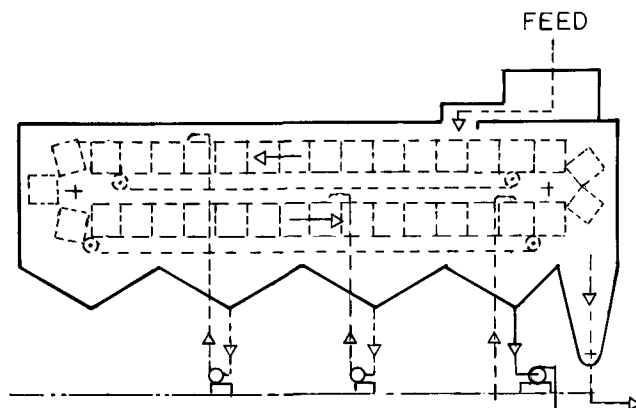

FIG. 5. Horizontal extractor.

extractor is the perforated belt type. The extraction takes place on a horizontal endless perforated belt. Cells are formed by creating ridges of flakes periodically, to act as barriers to backflow of miscella which otherwise could result in loss of extraction efficiency. This design is illustrated by the De Smet Extractor.

Chain conveyor type: The fourth type of percolation extractor is the chain conveyor unit in which a double drag chain and flight move inside a stationary casing, conveying the extracting solids over two sections of wedge wire screen. This type is illustrated by the Crown extractor, which combines percolation and immersion principles.

Filter type: The fifth type of percolation extractor is the vacuum filter system, in which the natural drainage force of gravity is assisted by pulling a vacuum under a filter cloth separation medium. This type is illustrated by the Wurster & Sanger Filtration Extractor, which employs a horizontal pan vacuum filter, separate miscella tanks, and a sophisticated vacuum pump system.

Immersion Extractors

Immersion extractors are very useful and are in service under the following conditions:

1. For extraction of small volumes or low capacities of conventional seeds
2. For direct extraction of high oil content seeds such as copra, safflower, peanut, cottonseed, and other seeds which tend to disintegrate and form fines upon extraction
3. For extraction in combination with percolation extractors in two-stage extraction systems
4. For extraction of low volumes of other materials such as pigments and pharmaceuticals from various plant materials.

The advantages of the immersion extractor are

1. Its simplicity of operation. It is not as sensitive to establishment of precise preparation conditions as is the percolation extractor. The immersion extractor, when properly designed, is able to extract efficiently very fine particles which could choke the bed of a percolation extractor.
2. Ease of operation. The liquid to solids ratios are not very critical, and the liquid flow rates are set to prevent backflow or carryover of fines. Since the immersion extractor easily accommodates a wide range of liquid and solids rates, it is not much affected by natural variations in these rates. It is also easily able to accommodate finely ground materials.

Commonly offered for special and direct extractions today are the Bernardini vertical design used in combination with their percolation extractor, and the EMI horizontal extractor used for a variety of specialty extractions such as fish protein concentrate and pigment extractions. In

medium followed by washing filtration of the two streams.

DESOLVENTIZERS

General Functions

The extracted flakes or presscake leaving the extractor will carry 25-40% by wt of solvent, which must be completely removed and recovered for return to the extraction process. This is done by evaporation by steam, in equipment designed for indirect heating, or direct steam addition, or a combination of the two. In addition, some oilseed meals require cooking to inactivate enzyme activity and destroy antidigestive factors to obtain optimum nutritional characteristics. This cooking, which is most effective with moist heat, is most conveniently done in the same equipment used for desolventizing. Thus the main functions of a conventional desolventizer are to desolventize and cook. Some desolventizers may also be used for drying to final meal moisture.

Indirect Heated

The earliest solvent extraction plants utilized banks of "Schneckens" or dryers, and these are still offered today. These consist of one or more banks of steam-jacketed horizontal ribbon or paddle conveyors arranged in vertical banks, sometimes discharging to a deodorizer vessel swept with live steam to remove final traces of solvent.

Live Steam Operated

Conventional D-T (Central Soya design): Of much greater importance to the high capacity processing of soybeans and other oilseeds today is the Desolventizer-Toaster, or D-T for short. The first of these units was designed by The French Oil Mill Machinery Co. and installed by Central Soya in 1950 and embodied the design features shown in Figure 6 (1). These are, with some variations, the same as are in use today. The machine consists of a series of circular steam-heated trays arranged vertically inside a vapor-tight shell. A central vertical shaft has attached to it sweep arms which rotate with a close clearance to the trays. The top tray sweep arms have perforated pipes through which live steam is admitted to the solvent-wet bed of flakes. The level of material on each tray is maintained by chutes or gates on each tray, and the overall level in the machine is maintained by variation in the speed of the discharge screw. In operation, the solvent-wet flakes enter at A and drop into the bed of flakes on tray 1. Live steam from the rotating pipe C vaporizes most of the solvent from the flakes, and the condensing steam increases the flake moisture content to over 20%. The process is explosive, which ruptures the internal flake structure and renders it more susceptible to uniform cooking for optimum nutrition. Vapor leaves the top and is scrubbed of fines before being condensed and recovered. The flakes then pass from tray to tray down through the machine where they are cooked and dried. The vapor passes upward through grids in the steam-heated trays.

This type of design is still used today with variations. The French Oil Mill D-T is equipped with individual level control gates on each tray and can also be furnished with chutes. The Dravo D-T is similar to the Central Soya design, and the EMI D-T is equipped with internal gates and chutes for meal level control by variable speed discharge. This type of D-T design is also furnished by De Smet, H.L.S. Ltd., Bernardini, Extraktionstechnik, Crown Iron Works, and Simon-Rosedowns.

Improved D-T designs: As plant capacities increased—from 100, 200, and 300 tons per day (TPD) to 1,000, 2,000, and now 3,000–4,000 TPD—the basic concept of the D-T remained almost the same, but it could no longer be used to also dry the meal; it could only be used for desolventizing and cooking. The first D-T design for high

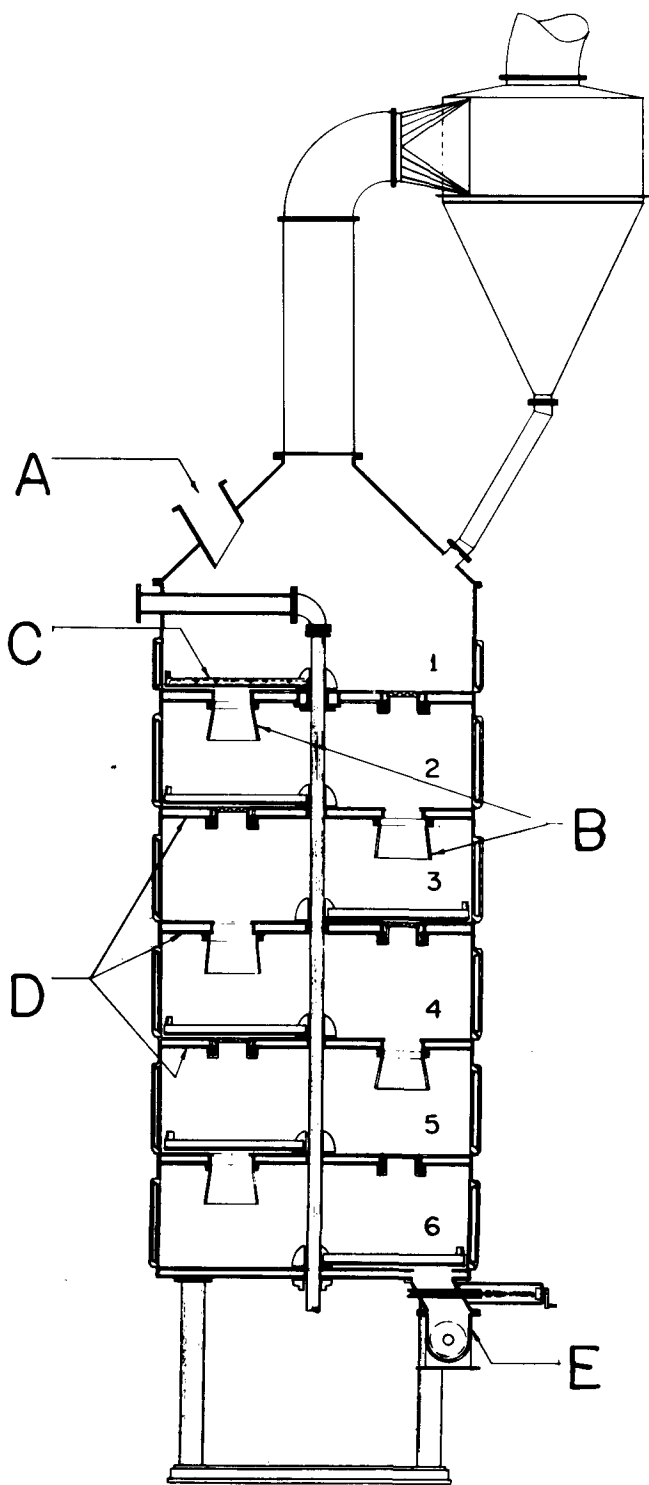

FIG. 6. Early desolventizer-toaster design.

addition, occasionally several other types and varieties of extractors will be found. For oilseed extraction, the principal ones are used for pilot plant or plant scale production of small quantities of extracted seeds for human or animal consumption. These include:

1. Combined mixer-settler tanks
2. Mixing tanks with continuous centrifugal separation with countercurrent washing steps
3. Mixing tanks with continuous filtration, with countercurrent washing steps
4. Elutriation tanks with vertical separation of solids by velocity, followed by washing filtration of the two streams
5. Liquid cyclone separation of solids in an extracting

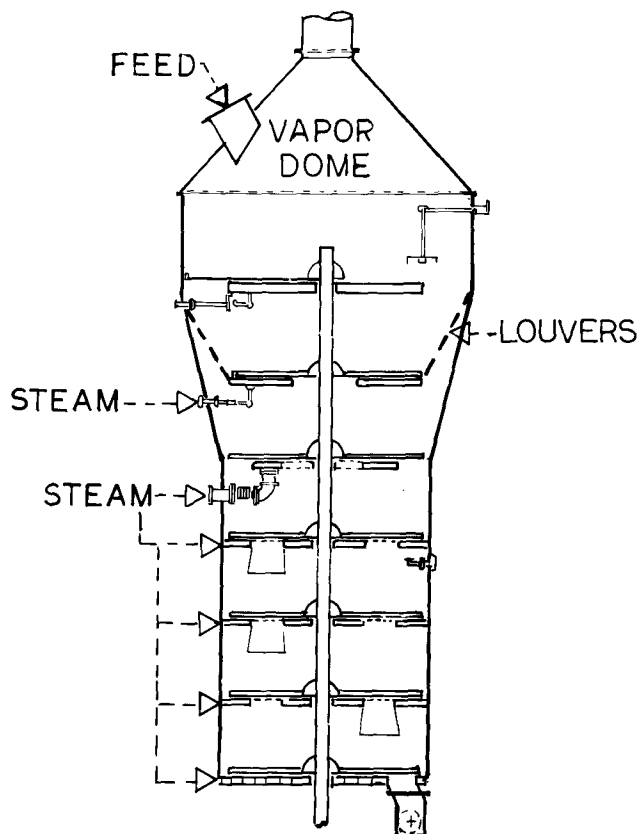

FIG. 7. Improved model desolventizer-toaster.

capacity desolventizing and cooking evolved largely as a result of basic research by Central Soya Company (1). Their improved D-T design for what was then considered high capacity—1,000 TPD—is shown with the main features identified (Fig. 7). An expanded vapor dome was added to reduce vapor velocity and minimize entrainment of flakes and fines. The top tray became a hot plate for partial desolventizing of the flakes. The third tray was perforated for addition of live steam, which was admitted into the flake bed in the tray above by means of louvered panels, thus permitting countercurrent passage of live steam and flakes with good contact between them. The three upper trays formed the desolventizing zone; the lower four trays formed the cooking zone. Normally with this type of D-T, optimum cooking is achieved within 10-12 min retention time and the D-T is designed to discharge meal at over 20% moisture, and temperatures of 100-110 C, requiring subsequent drying and cooling.

The extremely large capacity processing plants being built today employ the same basic design as the original Central Soya unit, with modifications which include additional sparging trays, live steam addition through sweep arms and pots in the annular space of the tray, increased diameters of trays and vapor domes, and drive horsepowers up to 250 HP, a far cry from the early models which required only 50 HP. These large capacity units are illustrated by the: Dravo design and Simon-Rosedowns, with internal chutes and variable speed discharge for level control; the French Oil Mill design, with either chutes and variable speed level control or individual tray level control; and the EMI design, with internal chutes and gates with variable speed discharge level control. All three are furnished with welded steel integral shell designs. Others are also available.

Another development in the conventional D-T is the Desolventizer-Toaster-Dryer-Cooler, developed by Heinz Schumacher. The internal construction of the D-T-D-C consists of a desolventizing and toasting zone using a perforated live steam tray, a drying section using hot air on

another tray, and a cooling section using cold air on the bottom tray.

Solvent Vapor Operated

There are many cases where uncooked desolventized flakes are desired—for specialty industrial products and products for human consumption and also for products with closely controlled protein solubility and light color. These products require desolventizing under more gentle heat conditions with minimum retention time at low temperature and at low moisture to minimize protein denaturation and produce the lightest possible color (2). These flakes are then heat-treated under carefully controlled conditions to strip residual solvent and produce high, medium, or low PDI (Protein Dispersibility Index) flakes as required, still with a light color.

The most widely used method for achieving this is by desolventizing the solvent-wet flakes in a superheated vapor stream of the same solvent, utilizing turbulent vapor heat transfer to evaporate the bulk of the solvent at the boiling point of the solvent.

The vapor desolventizer furnished by Dravo is a horizontal cylindrical vessel with a rotating cage arranged to lift and shower the flakes through a stream of hot solvent vapor which flows through the unit. A blower circulates cooled vapor through an external heater and back to the vessel, while the net solvent evolved is scrubbed and condensed for reuse. The residual solvent which remains in the flakes is stripped in a deodorizer vessel with sparge steam, leaving uncooked flakes. If cooked flakes are desired, a third vessel is added, a horizontal pressure toaster with an inner shell revolving on trunnions and in which the flakes are cooked by exposure to live steam under pressure. The overall retention time in the three units is said to be 33-47 min (R.D. Good, personal communication).

The Flash Desolventizing System furnished by EMI consists of a desolventizing tube, flake separator, circulating blower and vapor heater, arranged in a closed loop system in which superheated solvent vapor is circulated continuously. Solvent-wet flakes are fed into the system and are entrained in and conveyed by the high velocity circulating vapor stream. Turbulent contact with superheated vapor results in the evaporation of most of the solvent from the flakes. Again, the vapor evolved is scrubbed and condensed for reuse.

The uncooked flakes then enter a horizontal vessel for removal of the small amount of residual solvent remaining, using superheated steam which acts as an inert carrier gas. If cooked flakes—or flakes with any controlled PDI—are to be made, the finishing system contains two horizontal agitated vessels which provide the steaming time needed for cooking, with adequate instruments for controlling the temperature and residence time in the vessels. The retention time in the flash tube is only a few seconds, while the stripper retention time is ca. 5 min for stripping only to 15-20 min for cooking if the second vessel is in place. The PDI of the product flakes is easily varied from 15 to 20 for fully cooked to up to 85 for uncooked flakes.

MEAL DRYERS AND COOLERS

As mentioned before, the Desolventizer-Toaster might not be used to produce final meal moisture content of 12-14%, particularly in plants of large capacity. Meal leaving the D-T at 110 C and 20% moisture must be dried, preferably to under 12%, and cooled to under 40 C if it is to be stored before shipping. If not, storage problems can be severe because of consolidation of the mass of meal which results in hangups and dropping of arched meal, with sometimes severe damage to the tanks.

Many plants employ a vertical stack cooker installed after the D-T for drying. These units are basically the same design as the D-T without live steam addition and with pro-

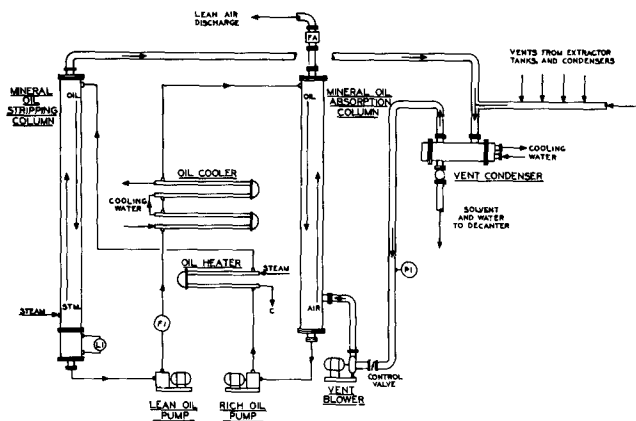

FIG. 8. Flow diagram: vent solvent recovery system.

visions for venting moisture. For large capacities, a rotary steam tube dryer is generally used which requires less space and is more economical than the vertical type.

For cooling following either a vertical stack unit or a rotary dryer, pneumatic cooling systems are regularly used up to 1,000 TPD capacity. They are efficient and economical in first cost and also are used to transport the meal to the warehouse or loading area.

The louver meal cooler offered by French is used for capacities up to 1,200 TPD. For capacities over this amount, a rotary cooler has usually been used because it provides adequate capacity with a reasonable cost, is economical to operate, and does not require an air filter.

De Smet offers a combination heater-cooler which is a vertical stack vessel with circular horizontal hot air drying trays followed by cold air trays. The Schumacher D-T-D-C unit has already been discussed. It is said to combine the functions of desolventizing, toasting, drying and cooling. Buhler-Miag offers a fluidized bed dryer-cooler for capacities of 2,000 metric tons per day of beans which is a self-contained unit with heating and air handling equipment.

DISTILLATION

Miscella distillation systems have developed over the years into three basic designs. The first is simple distillation without steam savings, generally utilized in the small capacity plant processing 100-200 TPD. Investment economy is the paramount consideration, and the steam savings are not sufficient to result in acceptable payout time.

The second is steam saving evaporation, using desolventizer-toaster vapors to vaporize part of the solvent in the miscella and using single stage evaporation for obtaining fully concentrated miscella (90% or more by wt) in those cases where the cooling water temperature available is sufficiently low to allow operation at high vacuum. This is followed by single stage oil stripping for final removal of

solvent.

The third miscella distillation system also utilizes desolventizer-toaster vapors but with two-stage evaporation, followed by two-stage oil stripping and oil drying in those cases where the cooling water temperature is high or air-cooled condensers are used. This latter design case is becoming more prevalent worldwide because of the increasing practice of water conservation and also because of the simple unavailability of cold cooling water in many parts of the world, both of which result in increasing reliance on cooling towers or air-cooled condensers.

All of the companies contacted furnished flowsheets and photos of distillation systems which were of the same general design with variations which each company has perfected. There are too many such to discuss in detail in this survey. The dual effect evaporation system of French is typical of the systems offered, as is their disc and donut final oil stripper.

SOLVENT RECOVERY

A typical vent solvent recovery system as might be installed in a modern solvent extraction plant is illustrated in Figure 8, which includes only the major process items for sake of clarity. This system consists basically of (A) water-cooled vent condenser, (B) mineral oil absorption column, (C) mineral oil stripping column, (D) oil heater and cooler, (E) circulating pumps, and (F) vent blower.

The vent blower maintains a slight negative pressure on the extractor and other process tanks and equipment, the level of which is adjusted by the control valve. Any air which enters the extractor with the feed and which enters any of the process equipment through small leaks is exhausted by the vent blower after first passing through the vent condenser. Here as much as possible of the accompanying solvent is removed by cooling in an indirect cooled tubular condenser. The coldest water entering the plant is used first in this condenser to provide the greatest amount of recovery and decrease the load on the mineral oil absorption system.

Again, this diagram is representative of the mineral oil solvent recovery systems offered by all of the companies contacted who furnished information and visual material.

ACKNOWLEDGMENTS

I would like to thank the following companies for furnishing material: Buhler-Miag, Inc.; Carter-Day, Inc.; Central Soya Co.; Costruzioni Meccaniche Bernardini, SpA; Crown Iron Works Co.; Dravo Corporation; EMI Corporation; The French Oil Mill Machinery Co.; H.L.S. Ltd.; Heinz Schumacher VDI; Lurgi Apparate-Technik, GmbH; Moorhead Machinery and Boiler Co.; Simon-Rosedowns, Ltd.; Speichim; and Wurster & Sanger.

REFERENCES

1. Sipos, E., and N.H. Witte, *JAOCS* 38:11 (1961).
2. Milligan, E.D., and J.F. Suriano, *Ibid.* 51:158 (1974).